





| Lýsing | FÍBER FÁNASTANGIR OG FYLGIHL. | Heiti | Vörunúmer |
|---|--------------------------------------|-------|---------------|
|  | FÍBER FÁNASTÖNG | 5mtr | DA 730505 |
| | Fánastangirnar eru afgreiddar með | 6mtr | DA 730506 |
| | gyltum fánahnúð, 5mm fánalínu | 7mtr | DA 730507 |
| | með krækjum og veltanlegri festingu | 8mtr | DA 730508 |
| | Vind álagsútreikningar liggja fyrir. | 9mtr | DA 730309 |
| | | 10mtr | DA 730310 |
| | | 11mtr | DA 730311 |
| | | 12mtr | DA 730512 |
| | infeld lína | 6mtr | DA 7305TN06L |
| | infeld lína | 10mtr | DA 7305TN010L |
| | infeld lína | 12mtr | DA 7305TN012L |

| | | | |
|---|--|--------------------|-------------|
|  | FÁNAHNÚÐUR | | |
| | Hnúðurinn er giltur og línan er þrædd í gegnum hann, hnúðurinn snýst svo minni hættu er á að fáninnvefjist um stöngina | fyrir 2-8mtr /50mm | DA 730813 |
| | | Fyrir 9-12mtr/65mm | DA 730813-1 |

| | | | |
|--|---------------------------|-------------------|-------------|
|  | FÁNALÍNA 5mm | 1mtr | FN 31025000 |
| | Úr ofnu polyesterefni. | fyrir 5mtr stöng | FA SLÍN5 |
| | Lengd línu miðast við | fyrir 6mtr stöng | FA SLÍN6 |
| | 2 x lengd stangar - 1mtr | Fyrir 8mtr stöng | FA SLÍN8 |
| | Línunni fylgja 2 krækjur. | Fyrir 10mtr stöng | FA SLÍN10 |
| | | Fyrir 12mtr stöng | FA SLÍN12 |

| | | | |
|---|---------------------------------|-------------------|---------------|
|  | Krækjur f.fána. | 2 stk í patningu | FA SKRÆ2 |
| | 2, 6, 10 stk í pakningu | 6 stk í patningu | FA SKRÆ6 |
| | Passa á staðlaða fána og veifur | 10 stk í patningu | FA SKRÆ10 |
| | | 12 stk í patningu | FA SKRÆ12 |
| | | stykkiðjavís >100 | DA 73.18.FLKR |

| | | | |
|---|--|--------|------------|
|  | Fánalínuhaldari | | |
| | Haldarinn er úr hvítu plasti og skrúfaður fastur á stöngina ca. 125cm frá jörðu. | v/2-6m | DA 7309135 |
| | | v/7-8m | DA 7309170 |

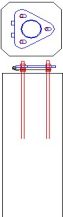
| | | | | | |
|---|-------------------------|------------------------|--------------|-------|----------------------|
|  | Jarðfestistöpull | | | | |
| | Járnbundin | breidd:25x25 lengd:68 | 4-6m stöng | 104kg | DA 7312TBS08 |
| | steypukubbur | breidd:30 lengd:80 | 6-8m stöng | 137kg | DA 7312TBS09 |
| | með festiboltum | breidd:30x30 lengd:80 | 10-11m störn | 172kg | Sérpöntun önnur járn |
| | f.stöng. | breidd: 40x40 lengd:95 | 12-16 mtr st | 371kg | Sérpöntun önnur járn |

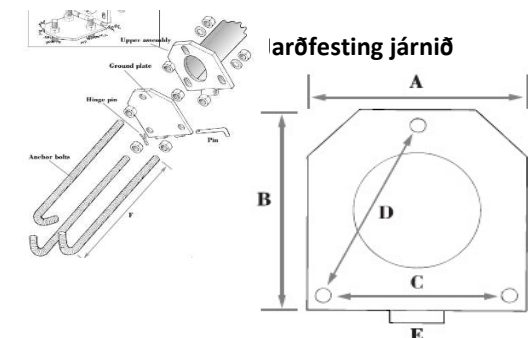

Jarðfesting járníð

| Item | Flagpole Height m | A Width mm | B Length mm | C Across mm | D Along mm | E Length mm |
|-------------|----------------------|------------------|-------------------|-------------------|------------------|-------------------|
| Hinged base | 4 - 8 m | 180 | 180 | 140 | 150 | 30 |
| Hinged base | 9 - 12 m | 230 | 230 | 170 | 170 | 49 |

Measurments C and D are from hole centre to hole centre.